





Pin configuration / electrical connection		
Electrical connection	M12x1, metal (5-pin)	
Supply +	1	
Supply -	3	
A (+)	2	
B (-)	4	
Reset	5	
Shield	plug housing	

**Dimensions (mm / in)**

**standard**

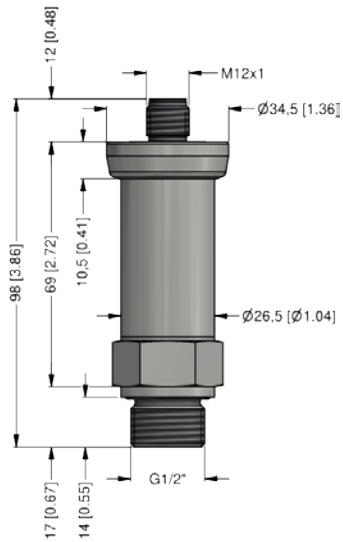

G1/2" DIN 3852 with M12x1

⇒ metric threads and other versions on request

**options**

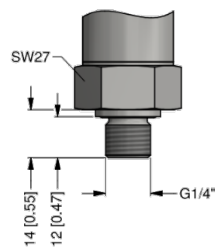

G1/4" DIN 3852

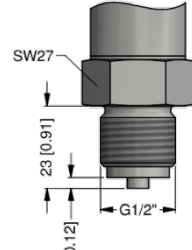

G1/2" EN 837

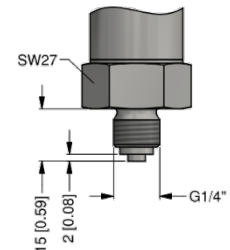

G1/4" EN 837

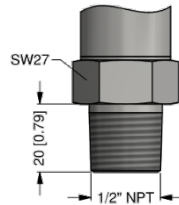

1/2" NPT

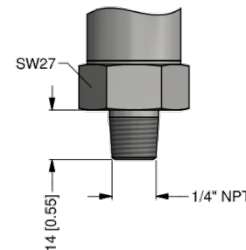

1/4" NPT

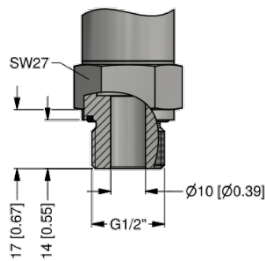

G1/2" DIN 3852 open port ( $p_N \leq 40$  bar)

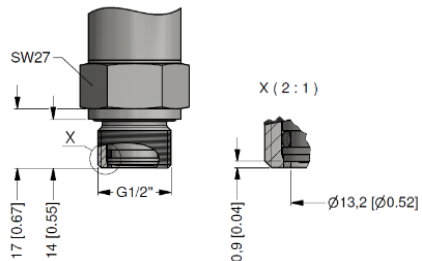

G1/2" DIN 3852 with semi-flush sensor ( $p_N \leq 40$  bar)

Configuration Modbus RTU						
Standard configuration	001	-	1	-	1	
<b>Address</b>						
Address	001					
	...					
	247					
<b>Baud Rate</b>						
4800 Bd			0			
9600 Bd			1			
19200 Bd			2			
38400 Bd			3			
<b>Parity</b>						
None						0
Odd						1
Even						2

Configuration code (to specify with order)	-	-			
--	---	---	--	--	--

