

Analogue Output options for INT4 and Fusion series

-ANI	4-20mA
-ANV	0-10V
-ANB	-10 to +10V



Warranty

We warrant our products against defects in materials or workmanship for a period of three (3) years from the date of purchase.

In the event of a defect during the warranty period, the unit should be returned, freight (and all duties and taxes) prepaid by the Buyer to the authorised distributor from where the unit was purchased.

The Distributor, at its option, will repair or replace the defective unit. The unit will be returned to the Buyer with freight charges prepaid by the distributor.

LIMITATION OF WARRANTY

The foregoing warranty shall not apply to defects resulting from:

1. Improper or inadequate maintenance by the buyer.
2. Unauthorised modification or misuse.
3. Operation outside the environmental specification of the product.
4. Mishandling or abuse.

The warranty set forth above is exclusive and no other warranty, whether written or oral is expressed or implied. We specifically disclaim the implied warranties of merchantability and fitness for a particular purpose.

EXCLUSIVE REMEDIES

The remedies provided herein are the buyer's sole and exclusive remedies.

In no event shall we be liable for direct, indirect, incidental or consequential damages (including loss of profits) whether based on contract, tort or any other legal theory.

Contents

General Description	4
Installation Hints	5
Wiring Advice	5
Zener barriers	5
ANI 4-20mA available responses	6
ANV 0-10V available responses	7
ANB -10V to +10V available responses	8
Analogue output board - configuring	9
Scaling the analogue output	10
Specifications	11
Connections and installing into a display	See main display manual*
Record of revisions	11
Warranty	2

* Need a manual urgently?
You can download manuals from our website.

General Description

This manual only covers the setup of the analogue output option. Please refer to the main display's operating manual for full specifications, installation methods, safety notices etc. You can download manuals from our website.

The analogue output option allows you to create an isolated analogue signal which is proportional to the value shown on the front of your display.

This can be used to feed remote devices such as data loggers, displays, PLCs and other peripheral equipment.

The outputs are active. That means the outputs are available directly, without needing external excitation power.

There are 2 different option boards available:-

1. Bipolar output board for -ANB, which gives an output range of -10V to +10V
2. Unipolar output board -ANI or -ANV which can be configured to give an output range of either 0-20mA, 4-20mA or 0-10V

These analogue output options have high resolution and precision, thanks to their 16 bit D/A architecture.

Scaling the output to cover your required measurement range is simple and only takes a few minutes to do.

You will easily find the analogue output setting button on the front of the display, it is the one marked OUTPUT , so you can get to the setting directly, without needing to find it in a menu.

The analogue output is derived from the displayed value, so if you adjust filtering for the display, the analogue output will also be filtered and will respond to any input changes at the same speed as the display.

The analogue output is updated 10 times per second.

Installation hints for best performance

This section offers several suggestions which will help you get the best performance from your analogue output.

1. Use good quality twisted-pair screened signal cable. Belden 8761NH (single pair), Belden 8777NH (multi-pair), Belden 9503 (multi-pair) and AlphaWire 6010C (multi-pair) are good choices, available from many electrical distributors.
2. The cable should be routed away from noisy wiring and devices such as power feeds from inverters, discharge-lighting cables, welder cabling etc, and should preferably be routed in a dedicated low voltage signalling/instrumentation conduit or cable tray.
3. Screened cable should be earthed at the destination end only.
4. All wires and screens coming out of the screened cable should be kept as short as possible to minimise pickup of noise.
5. If you are using barriers, you should earth your screen as shown below, paying particular care that you do not earth both ends of any run of of cable.
6. If you are feeding the analogue output to a PLC, data logger or other device with an A/D converter, you should set a sample time of around 100mS and ensure that the signal is averaged during this period. This will ensure optimum noise performance without degrading response speed.

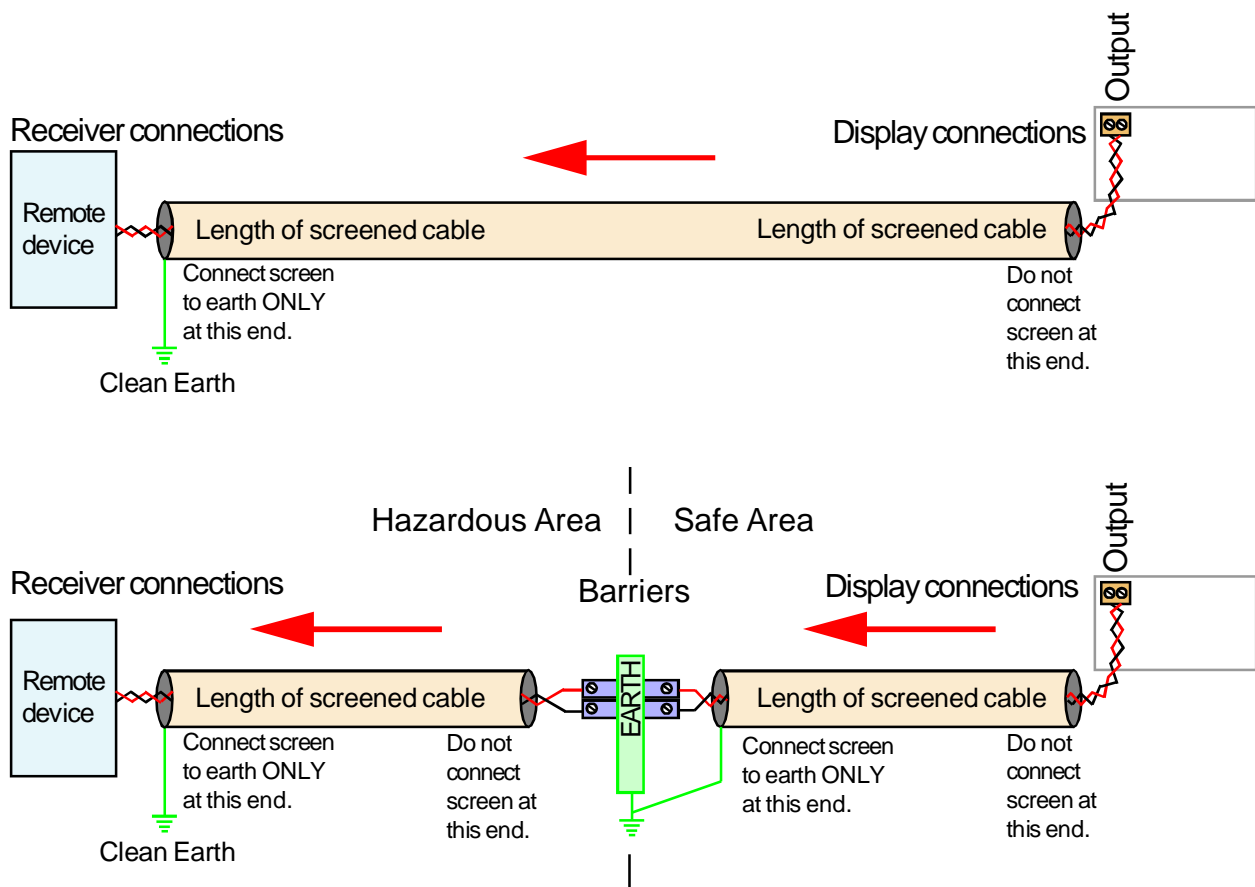

ANI 4-20mA output, available responses

Complete flexibility and simplicity of scaling for your 4-20mA analogue output signal .
Directly proportional and inversely proportional, symmetrical and assymetrical, zero based display and offset display, all set with just 2 parameters!

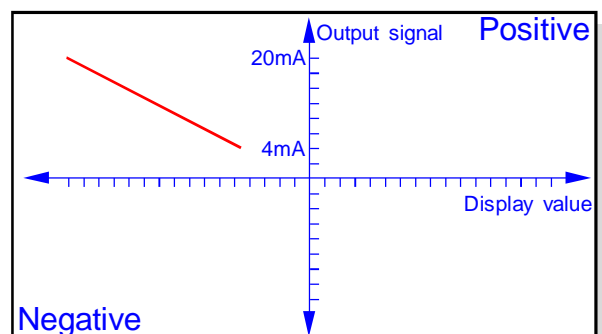
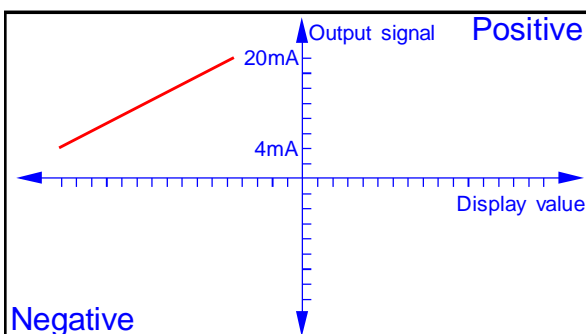
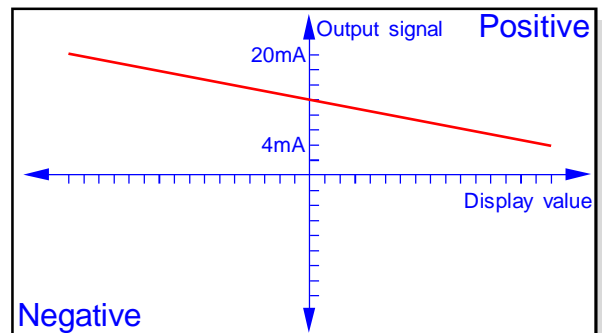
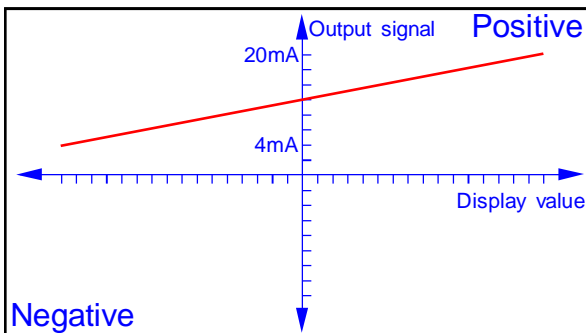
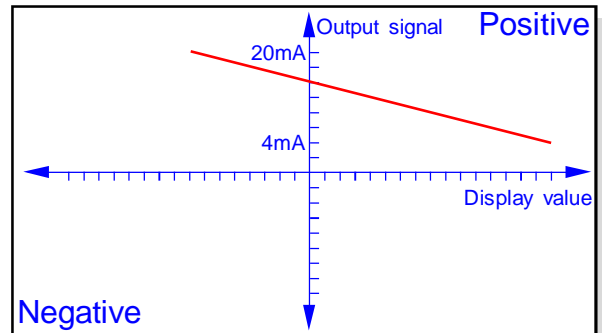
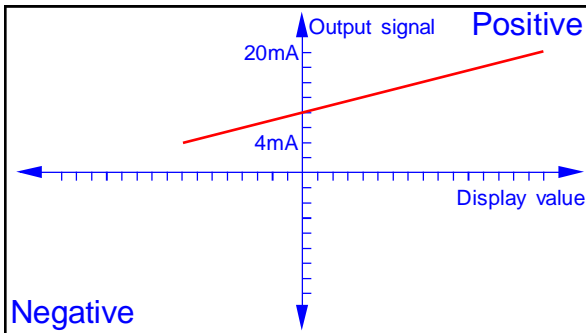
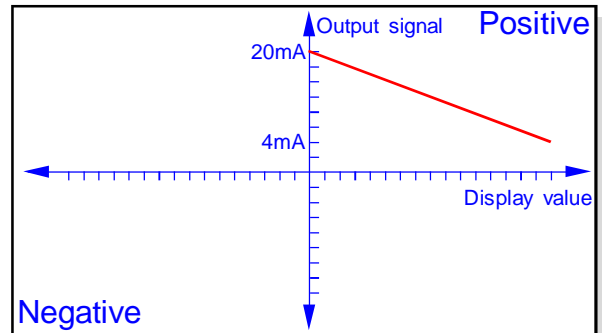
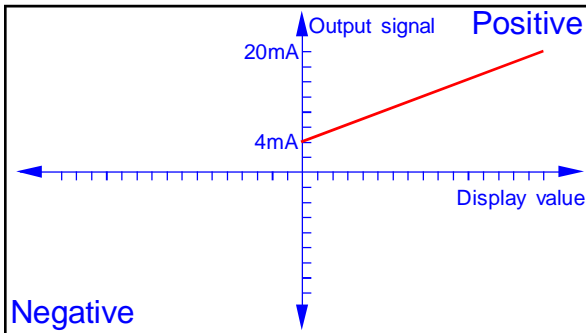
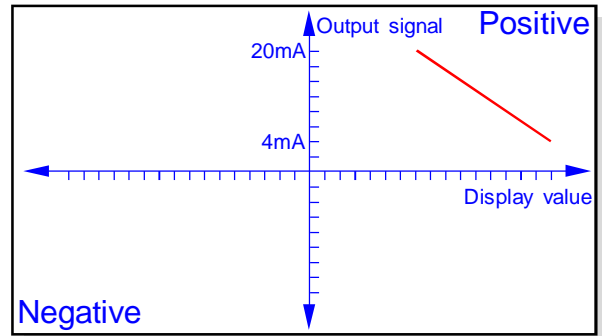
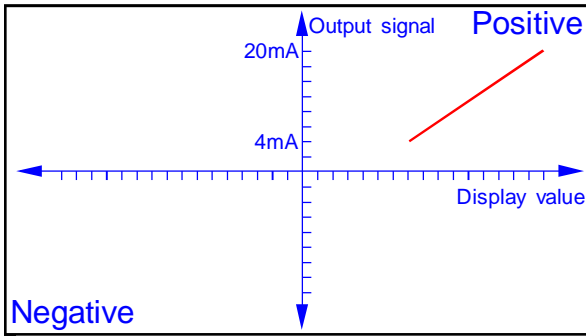

ANV 0 to +10V output, available responses

Complete flexibility and simplicity of scaling for your 0-10V analogue output signal . Directly proportional and inversely proportional, symmetrical and assymetrical, zero based display and offset display, all set with just 2 parameters!

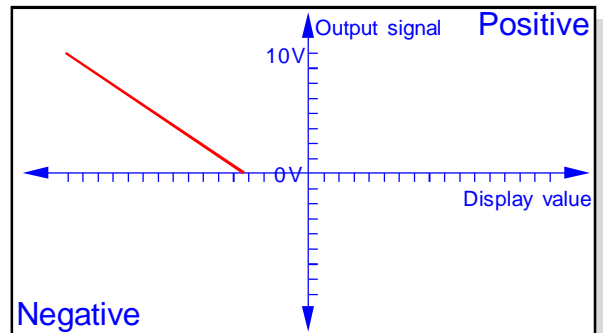
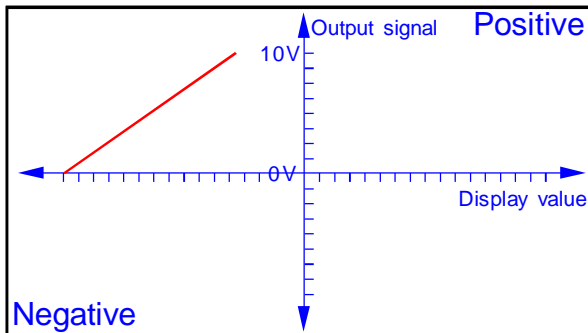
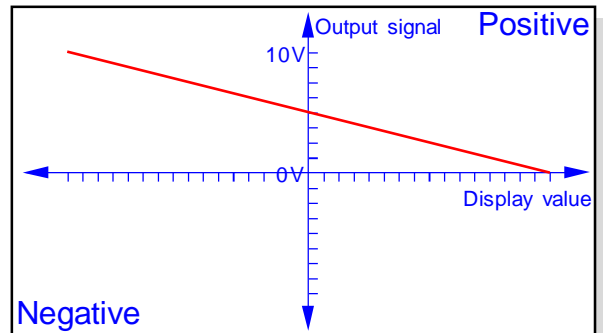
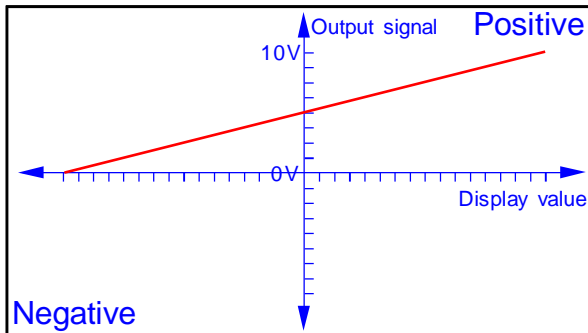
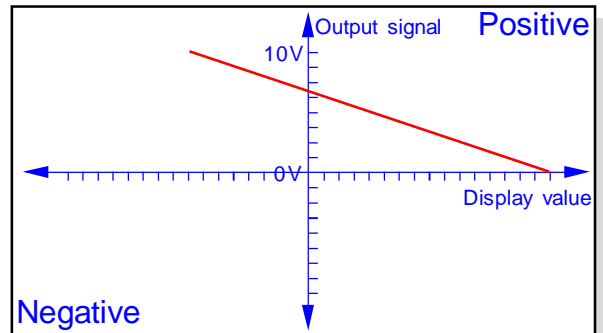
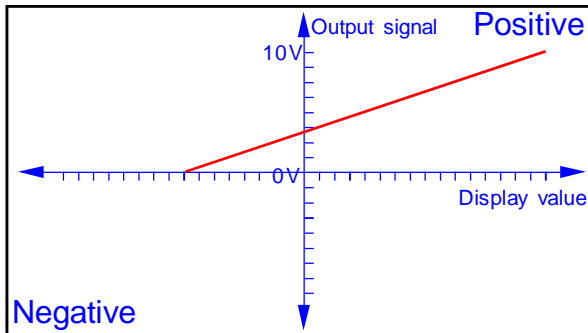
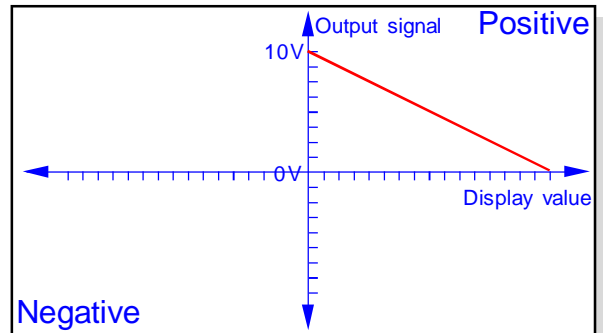
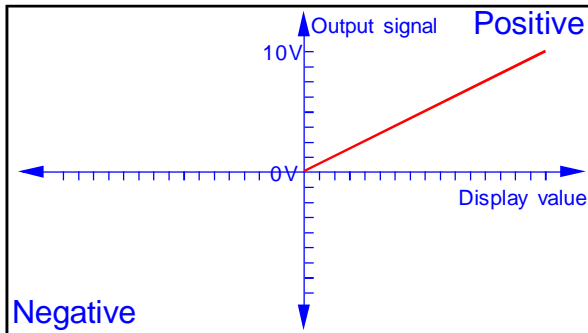
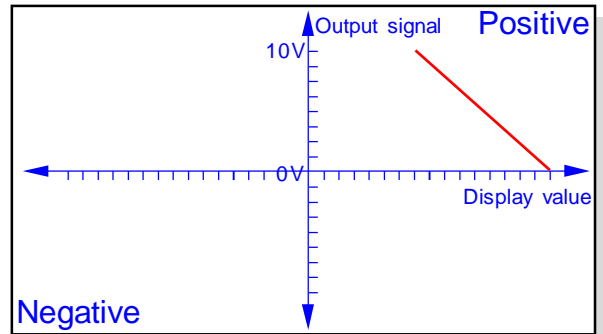
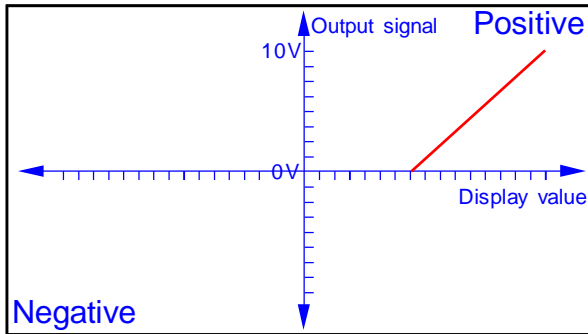

ANB -10 to +10V available responses

Complete flexibility and simplicity of scaling for your -10V to +10V analogue output signal .
Directly proportional and inversely proportional, symmetrical and assymetrical, zero based display and offset display, all set with just 2 parameters!

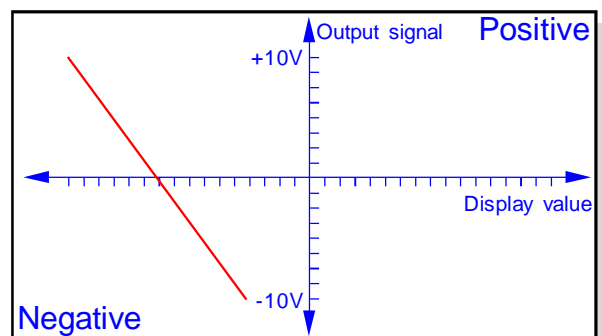
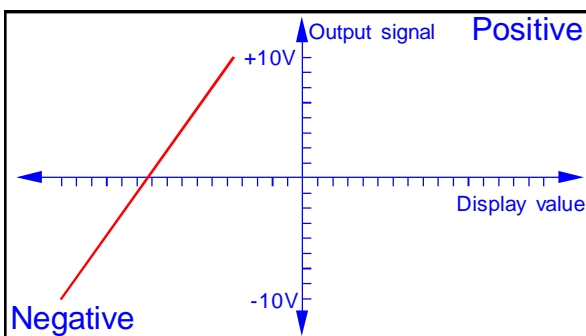
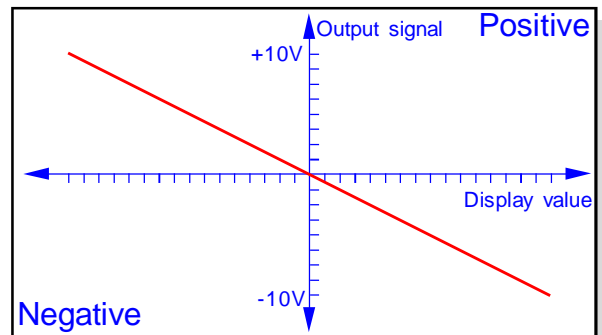
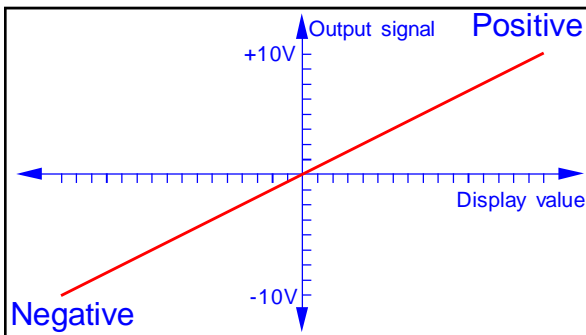
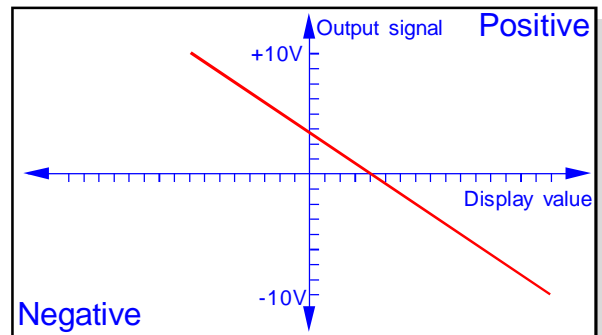
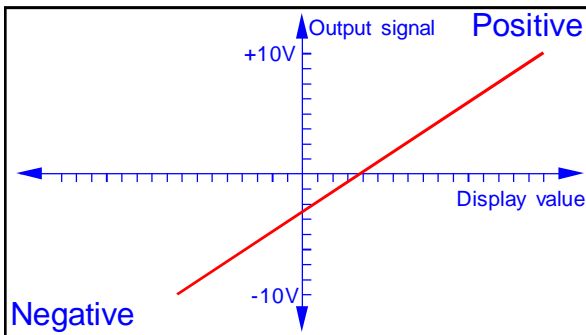
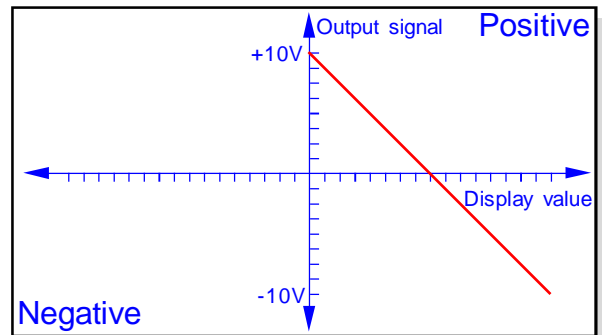
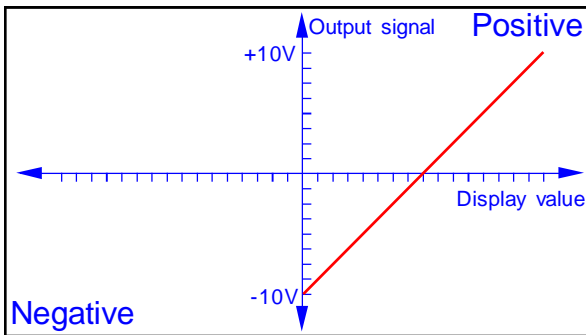
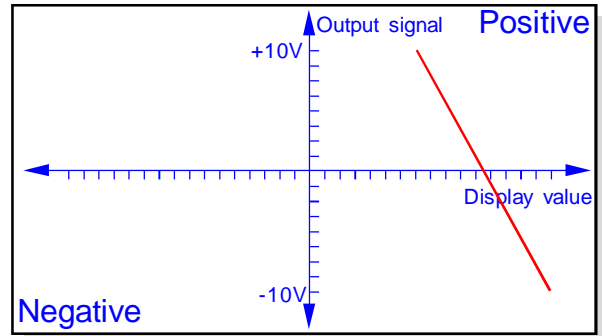
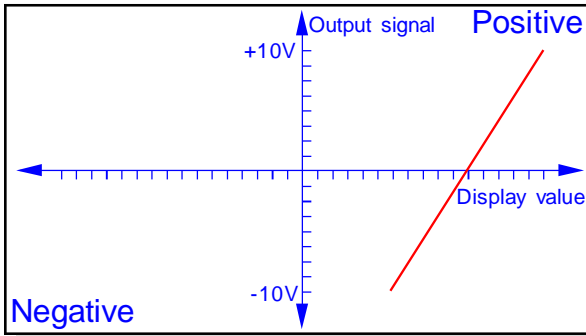

Analogue output board configuring

You can adjust your display to generate an analogue output over a chosen numeric display range.

For example you could have 4-20 mA output, where 4mA occurs at 0 on the display and 20mA occurs at 2500.0 on the display. Or, you may want the analogue output to be reverse acting, so you could set 4mA to occur at 500 on the display and 20mA to occur at 125 on the display.

You have complete freedom on the numeric display limits which correspond to your analogue output. They can both be positive, one negative and one positive, or both negative.

There are two board types, one for single polarity output such as 4-20mA and 0-10V, the other for -10V to +10V output. The appropriate one will be fitted in your display, according to your order.

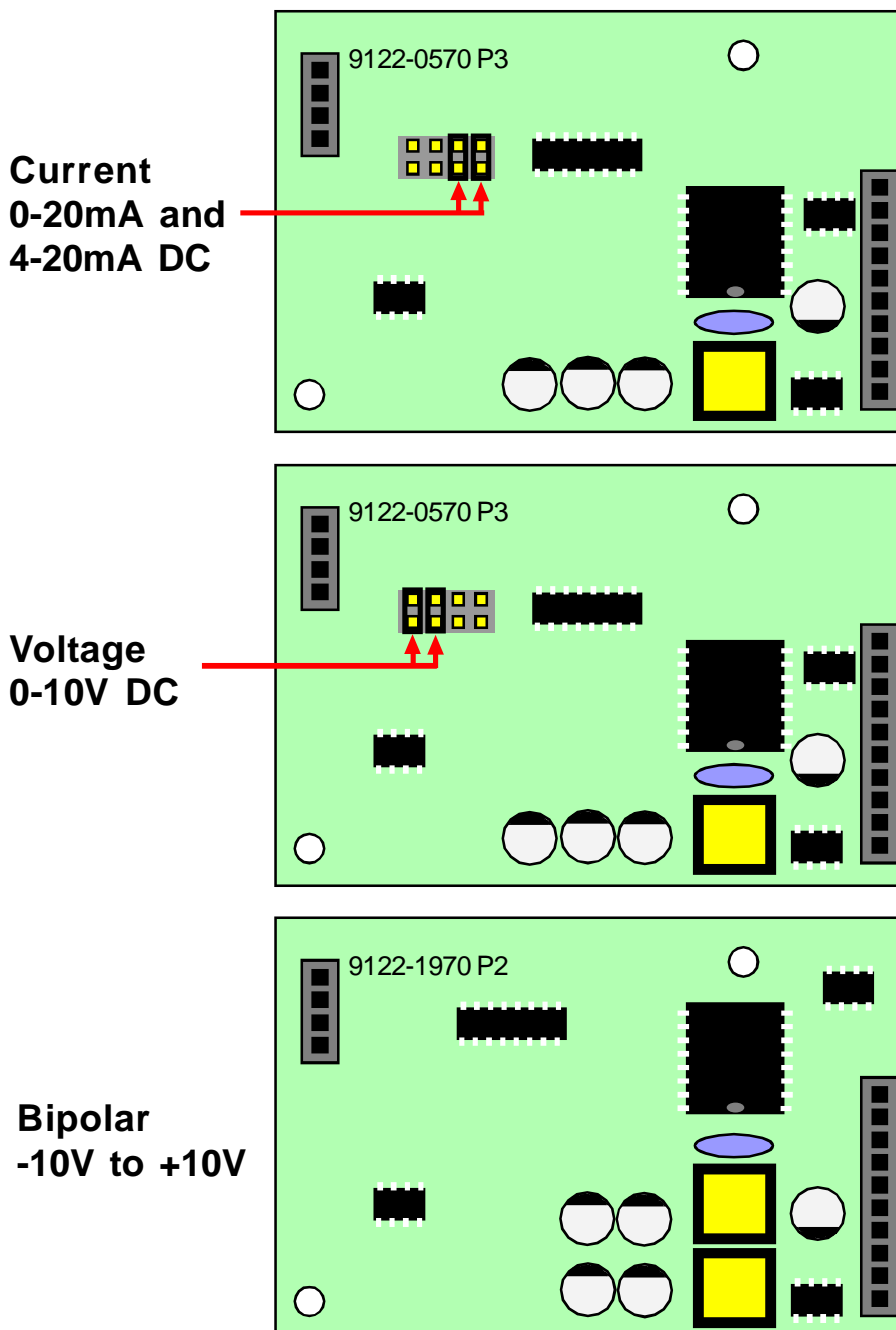

Scaling your Analogue output

1

Press for 3 seconds

Lockout Switch must be OFF

Circuit board ON

2

Press to toggle between 0-20mA and 4-20mA if board jumpers are set for current

Display shows **OutPut** followed by the present output range of either 4-20mA, 0-20mA, 0-10V or Bipolar -10 to +10V

If your display does not yet have an analogue output board fitted, the display will show **no Out**

Press "OK" when ready for next step...

3

Press to select Net or Gross

Now choose **Net** if you want the output to be proportional to the Net value of your measurement (value after taring), or **Gross** if you want the output to be derived from the Gross calibrated value of your measurement. Then press OK.

4

Display now says **Out Lo** and 0% LED will light, Use DIGIT, UP and DOWN buttons to set the display value at which your lowest analogue output signal is to be created. Press OK when done.

5

Display now says **Out H**, and 100% LED will light, Use DIGIT, UP and DOWN buttons to set the display value at which your highest analogue output signal is to be created. Press OK when done.

6

Press to accept

Done!

Specifications

Output signal	0-10VDC	-10 to +10V	0-20mA	4-20mA
Drive capacity	>1K Ohms	>1K Ohms	<500 Ohms	<500 Ohms

Isolation	250 VAC Optically isolated from input, logic, excitation, power, alarms and serial communications ports
Accuracy	+/-0.1%of range, +/-10mV for ANV, +/-10uA for ANI
Thermal stability - gain	+/-50ppm/C stab.
Linearity	+/-0.02% of range
Resolution	16 bit D/A. Better than 0.2mV for 10v, 0.4uA for 20mA range
Scaling	Fully adjustable, direct or inverse. Can be derived from Nett or Gross value
Response speed	Derived from displayed value, which is updated 10 times per second. Any filtering applied to the display will be applied to the analogue output also.
Linearisation	The analogue output is derived from the displayed value, so if your display has a non linear response, and you are using the display's lineariser function, the output will follow the display directly.

Record of Revisions

20 August 2010	Revision 0 version of manual released.
26 November 2010	Revision 2. Software F00.20 released
2 February 2011	Software F00.21 released
28 February 2011	Warranty increased to 3 years and terms added.

We design and manufacture a wide range of standard and custom monitoring and control equipment.

All our UK manufactured products have a 3 year warranty.

Real-Time Production-Line Displays

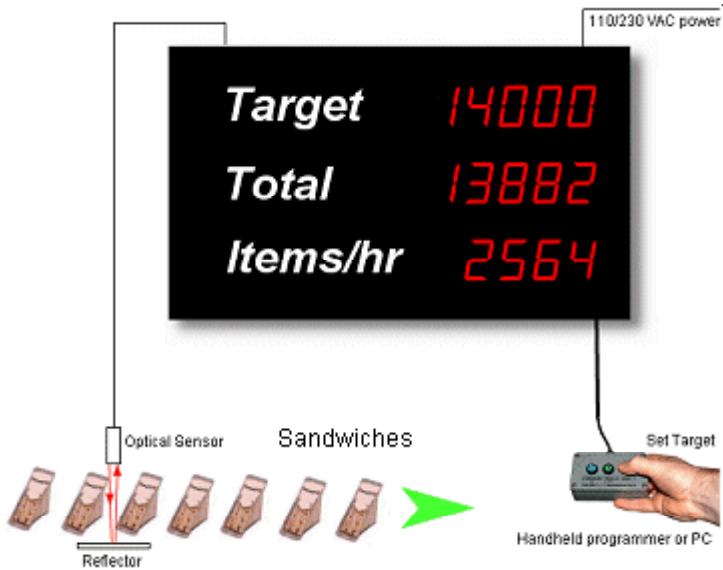

Large Digital Displays sealed IP65



Digital Panel Meters



Power Monitors



Bargraph Displays



Message Displays sealed IP65

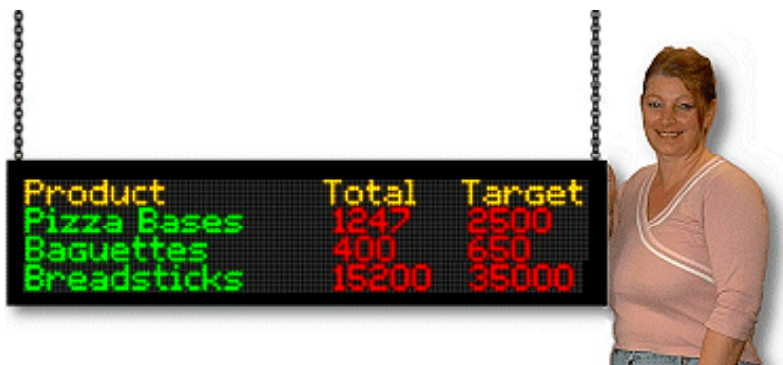

Signal Transmitters / Isolators

