

Operating Manual

Pressure transmitters / screw-in transmitters for IS-areas

DX14-DMK 351, DX14-DMK 351 P, DX14-LMK 351, DX14B-DMK 387, DX19-DMK 331, DX19-DMK 331 P, DX19-DMP 311, DX19-DMP 321, DX19-DMP 331, DX19-DMP 331 i, DX19-DMP 331 P, DX19-DMP 331 Pi, DX19-DMP 333, DX19-DMP 333 i, DX19-DMP 334, DX19-DMP 335, DX19-DMP 336, DX19-DMP 339, DX19-DMP 343, DX19-LMK 331, DX19-LMP 331, DX19-LMP 331i, DX19-17.600G, DX19-17.605G, DX19-26.600G



**READ THOROUGHLY BEFORE USING THE DEVICE
KEEP FOR FUTURE REFERENCE**

ID: BA_DMU-ES_EX_E | Version: 04.2023.0

1. General and safety-related information on this operating manual

This operating manual enables safe and proper handling of the product, and forms part of the device. It should be kept in close proximity to the place of use, accessible for staff members at any time.

All persons entrusted with the mounting, installation, putting into service, operation, maintenance, removal from service, and disposal of the device must have read and understood the operating manual and in particular the safety-related information.

The following documents are an important part of the operating manual:

- data sheet
- type-examination certificate

For specific data on the individual device, please refer to the respective data sheet.

Download these by accessing www.bdsensors.de or request them: info@bdsensors.de | phone: +49 (0) 92 35 / 98 11 0

The IS versions of our products are variants of the standard products.

Example:

Standard: DMK 351 → IS version: DX14-DMK 351

In addition, the applicable accident prevention regulations, safety requirements, and country-specific installation standards as well as the accepted engineering standards must be observed.

For the installation, maintenance and cleaning of the device, the relevant regulations and provisions on explosion protection (VDE 0160, VDE 0165 and/or EN 60079-14) as well as the accident prevention regulations must absolutely be observed.

The device was designed by applying the following standards:

DX14: EN IEC 60079-0:2018; EN 60079-11:2012

DX14B: EN 60079-0:2018; EN 60079-11:2012;

IECEX IBE 18.0019X: IEC 60079-0: 2011 Edition 7;

IEC 60079-11: 2011 Edition 6

DX19: EN IEC 60079-0:2018; EN 60079-11:2012;

IECEX IBE 12.0027X: IEC 60079-0: 2011 Edition 6;

IEC 60079-11: 2011 Edition 6

1.1 Symbols used

	- Type and source of danger - Measures to avoid the danger
--	---

Warning word	Meaning
	- Imminent danger! - Non-compliance will result in death or serious injury.
	- Possible danger! - Non-compliance may result in death or serious injury.
	- Hazardous situation! - Non-compliance may result in minor or moderate injury.

NOTE - draws attention to a possibly hazardous situation that may result in property damage in case of non-compliance.

- ✓ Precondition of an action

1.2 Staff qualification

Qualified persons are persons that are familiar with the mounting, installation, putting into service, operation, maintenance, removal from service, and disposal of the product and have the appropriate qualification for their activity.

This includes persons that meet at least one of the following three requirements:

- They know the safety concepts of metrology and automation technology and are familiar therewith as project staff.
- They are operating staff of the measuring and automation systems and have been instructed in the handling of the systems. They are familiar with the operation of the devices and technologies described in this documentation.
- They are commissioning specialists or are employed in the service department and have completed training that qualifies them for the repair of the system. In addition, they are authorized to put into operation, to ground, and to mark circuits and devices according to the safety engineering standards.

All work with this product must be carried out by qualified persons!

1.3 Intended use

The device is intended for converting the physical parameter of pressure into an electric signal. It has to be used only for this purpose, considering the following information.

The above listed pressure transmitters have, according to the type, been developed for applications in overpressure and vacuum as well as for absolute pressure measurement.

The screw-in transmitters are intended for level and process measurement.

Devices with 3-A and / or EHEDG certified process connection have been developed especially for applications in food and pharmaceutical industry. The process connection is hygienic and can be sterilized.

Permissible measuring and cleaning media are gases or liquids, which are compatible with the media wetted parts of the device (according to data sheet) and your system. This must be ensured for the application.

This operating manual applies to devices with explosion protection approval and is intended for the use in IS-areas. A device has an explosion-protection approval if this was specified in the purchase order and confirmed in our order acknowledgement. In addition, the manufacturing label includes a sign.

The user must check whether the device is suited for the selected use. In case of doubt, please contact our sales department: info@bdsensors.de | phone: +49 (0) 92 35 98 11 0

BD|SENSORS assumes no liability for any wrong selection and the consequences thereof!

The technical data listed in the current data sheet are engaging and must absolutely be complied with. If the data sheet is not available, please order or download it from our homepage: <http://www.bdsensors.de>

1.4 Incorrect use

	Danger through incorrect use - Only use the device in permissible media and in accordance with its intended use. - Do not use the device as a ladder or climbing aid. - The device must not be altered or modified in any way. - BD SENSORS is not liable for damage caused by improper or incorrect use.
--	--

1.5 Limitation of liability and warranty

Failure to observe the instructions or technical regulations, improper use and use not as intended, and alteration of or damage to the device will result in the forfeiture of warranty and liability claims.

1.6 Safe handling

NOTE - Do not use any force when installing the device to prevent damage of the device and the plant!

NOTE - Treat the device with care both in the packed and unpacked condition!

NOTE - Do not throw or drop the device!

NOTE - Excessive dust accumulation and complete coverage with dust must be prevented!

NOTE - The device is state-of-the-art and is operationally reliable. Residual hazards may originate from the device if it is used or operated improperly.

1.7 Safety-related maximum values

DX14-...:

$U_i = 28 V$, $I_i = 93 mA$, $P_i = 660 mW$, $C_i = 14 nF$, $L_i = 0 \mu H$;

$C_{ind} = 27 nF$; plus cable inductivities $1.5 \mu H/m$ and cable capacities $220 pF/m$ (for cable by factory)

application in zone 0 (p_{atm} 0.8 bar up to 1.1 bar): -20 ... 60 °C

application in zone 1 and higher: -25 ... 70 °C

devices with temperature class T6: -25 ... 60 °C

DX14B-DMK 387:

$U_i = 28 V$, $I_i = 93 mA$, $P_i = 660 mW$, $C_i = 14 nF$, $L_i = 0 \mu H$;

$C_{ind} = 27 nF$; plus cable inductivities $1 \mu H/m$ and cable capacities $160 pF/m$ (for cable by factory)

application in zone 0 (p_{atm} 0.8 bar up to 1.1 bar): -20 ... 60 °C

application in zone 1 and higher: -25 ... 65 °C

DX19-...:

$U_i = 28 V$; $I_i = 93 mA$; $P_i = 660 mW$; $C_i \approx 0 nF$; $L_i = 0 \mu H$;

$C_{ind} = 27 nF$; plus cable inductivities $1 \mu H/m$ and cable capacities $160 pF/m$ (for cable by factory)

application in zone 0 (p_{atm} 0.8 bar up to 1.1 bar): -20 ... 60 °C

application in zone 1 and higher: -40/-20 ... 70 °C

application in zone 1 and higher for **type DX19-***i**: -40/-20 ... 65 °C

1.8 Scope of delivery

Check that all parts listed in the scope of delivery are included free of damage, and have been delivered according to your purchase order:

- pressure transmitter or screw-in transmitter
- for mechanical pressure ports DIN 3852: O-ring (pre-mounted)
- this operating manual
- for SIL2 version: safety data sheet

1.9 UL approval (for devices with UL marking)

The UL approval was effected by applying the US standards, which also conform to the applicable Canadian standards on safety.

Observe the following points so that the device meets the requirements of the UL approval:

- only indoor usage
- maximum operating voltage: according to data sheet
- The device must be operated via a supply with energy limitation (acc. to UL 61010) or an NEC Class 2 energy supply.

2. Product identification

The device can be identified by means of the manufacturing label with order code. The most important data can be gathered therefrom.

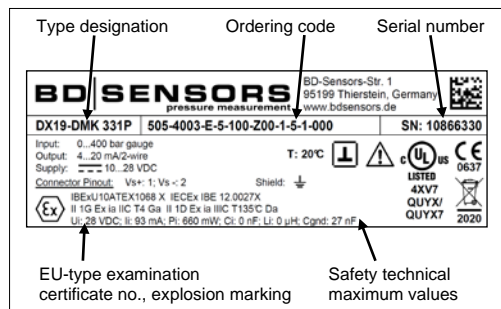

Fig. 1: Example of manufacturing label

NOTE - The manufacturing label must not be removed!

The marking for devices with explosion-protection approval has to include following information:

DX14-...:

EU-type examination certificate IBExU05ATEX1070 X

metallic pressure port: II 1G Ex ia IIC o. IIB T6 o. T4 Ga

II 1D Ex ia IIIC T110°C Da

non-metallic pressure port: II 1/2G Ex ia IIC T4 Ga/Gb

II 1/2D Ex ia IIIC T110°C Da/Db

DX14B-DMK 387:

EU-type examination certificate IBExU15ATEX1066 X

metal housing: II 1G Ex ia IIC T4 Ga

PVDF or PP housing: II 2G Ex ia IIC T4 Gb

all types: II 1D Ex ia IIIC T135 °C Da

DX19-...:

EU-type examination certificate IBExU10ATEX1068 X

non-metallic pressure port: II 2G Ex ia IIC T4 Gb

II 2D Ex ia IIIC T85°C Db

metallic pressure port: II 1G Ex ia IIC T4 Ga

II 1D Ex ia IIIC T135°C Da

3. Mounting

3.1 Mounting and safety instructions

	DANGER - Always mount the device in a depressurized and de-energized condition! - Do not install the device while there is a risk of explosion.
	DANGER - Explosion hazard due to high-charging processes in connection with free-hanging submersible transmitters with cable FEP - Fixed installation of the FEP cable!

NOTE - The technical data listed in the EU-type examination certificate are binding. Download this by accessing www.bdsensors.de or request it by e-mail or phone: info@bdsensors.de | phone: +49 (0) 92 35 98 11 0

NOTE - Make sure that the entire interconnection of intrinsically safe components remains intrinsically safe. The owner-operator is responsible for the intrinsic safety of the overall system (entire circuitry).

NOTE - If there is increased risk of damage to the device by lightning strike or overvoltage, increased lightning protection must additionally be provided!

NOTE - Treat any unprotected diaphragm with utmost care; this can be damaged very easily.

NOTE - Provide a cooling line when using the device in steam piping and clarify the material compatibility.

NOTE - The measuring point must be designed in such a way that cavitation and pressure surges are avoided.

NOTE - When installing the device, avoid high mechanical stresses on the pressure port! This will result in a shift of the characteristic curve or to damage, in particular in case of very small pressure ranges and devices with a pressure port made of plastic.

NOTE - In hydraulic systems, position the device in such a way that the pressure port points upward (ventilation).

NOTE - If the device is installed with the pressure port pointing upwards, ensure that no liquid drains off on the device. This could result in humidity and dirt blocking the gauge reference in the housing and could lead to malfunctions. If necessary, dust and dirt must be removed from the edge of the screwed joint of the electrical connection.

NOTE - Do not remove the packaging or protective caps of the device until shortly before the mounting procedure, in order to exclude any damage to the diaphragm and the threads! Protective caps must be kept! Dispose of the packaging properly!

NOTE - The permissible tightening torque depends on the conditions on site (material and geometry of the mounting point). The specified tightening torques for the pressure transmitter must not be exceeded!

NOTES - for mounting outdoors or in a moist environment:

- Please note that your application does not show a dew point, which causes condensation and can damage the pressure transmitter. There are specially protected pressure transmitters for these operating conditions. Please contact us in such case.
- Connect the device electrically straightaway after mounting or prevent moisture penetration, e.g. by a suitable protective cap. (The ingress protection specified in the data sheet applies to the connected device.)
- Select the mounting position such that splashed and condensed water can drain off. Stationary liquid on sealing surfaces must be excluded!
- If the device has a cable outlet, the outgoing cable must be routed downwards. If the cable needs to be routed upwards, this must be done in an initially downward curve.
- Mount the device such that it is protected from direct solar radiation. In the most unfavourable case, direct solar radiation leads to the exceeding of the permissible operating temperature. This must be excluded if the device is used in any explosion-hazardous area!
- For devices with gauge reference in the housing (small hole next to the electrical connection), install the device in such a way, that the gauge reference is protected from dirt and moisture. Should the device be exposed to fluid admission, the functionality will be blocked by the gauge reference. An exact measurement in this condition is not possible. Furthermore, this can lead to damages on the device.

3.2 Conditions for devices with 3-A symbol

The device or its connecting piece must be installed in such a way that the surfaces are self-draining (permissible installation position 273° ... 87°).

Make sure that the welding socket is mounted flush inside the tank.

The user is responsible for:

- the correct size of the seal and the choice of an elastomeric sealing material that complies with the 3-A standard
- an easy to clean installation position of the pressure transmitter with little dead space, as well as definition / verification / validation of a suitable cleaning process
- defining adequate service intervals

3.3 Conditions for devices, with EHEDG certificate

Install the device according to the requirements given in EHEDG Guidelines 8, 10 and 37. That is to mount the device in a self-draining orientation. The device should be installed flush to the process area. If mounting in a T-piece, the ratio between the depth of the upstand (L) and the diameter (D) of the upstand shall be L/D < 1. If welded adapters are used, the food contact surface must be smooth, and the welding has to be done according to EHEDG Guideline 9 and 35. Suitable pipe couplings and process connections must be applied according to the EHEDG Position Paper. (List the available ones.)

3.4 Conditions for oxygen applications

	DANGER - Danger of death from explosion - when used improperly
--	---

Make sure that your device was ordered for oxygen applications and delivered accordingly. (see manufacturing label - ordering code ends with the numbers "007")

Unpack the device directly prior to the installation. Skin contact during unpacking and installation must be avoided to prevent fatty residues remaining on the device. Wear safety gloves!

The entire system must meet the requirements of BAM (DIN 19247)!

For oxygen applications > 25 bar, devices without seals are recommended.

Transmitters with o-rings of FKM (V1 567): permissible maximum values: 25 bar / 150° C (BAM approval)

3.5 Mounting steps for connections according to DIN 3852

NOTE - Do not use any additional sealing material such as yarn, hemp or Teflon tape!

- ✓ The O-ring is undamaged and seated in the designated groove.
- ✓ The sealing face of the mating component has a flawless surface. (Rz 3.2)

- 1 Screw the device into the corresponding thread by hand.
- 2 Devices equipped with a knurled ring: only tighten by hand
- 3 Devices with a spanner flat must be tightened using a suitable open-end wrench. Permissible tightening torques for pressure transmitter:
 - wrench flat made of steel:
 - G1/4": approx. 5 Nm
 - G1/2": approx. 10 Nm
 - G3/4": approx. 15 Nm
 - G1": approx. 20 Nm
 - G1 1/2": approx. 25 Nm
 - wrench flat made of plastic: max. 3 Nm

3.6 Mounting steps for connections according to EN 837

- ✓ A suitable seal for the medium and the pressure to be measured is available. (e.g. a copper seal)
 - ✓ The sealing face of the mating component has a flawless surface. (Rz 6.3)
- 1 Screw the device into the corresponding thread by hand.
 - 2 Then tighten it using an open-end wrench. Permissible tightening torques for pressure transmitter:
 - G1/4": approx. 20 Nm; G1/2": approx. 50 Nm

NOTE - permitted pressure ranges according to EN 837

G1/4" EN 837	$p \leq 600 \text{ bar}$	Counterpart has to be of steel according to DIN 17440 with strength $R_{p0.2} \geq 190 \text{ N/mm}^2$
G1/2" EN 837	$p \leq 1000 \text{ bar}$	Counterpart has to be of steel according to DIN 17440 with strength $R_{p0.2} \geq 260 \text{ N/mm}^2$
G1/4" EN 837	$p > 600 \text{ bar}$, $p \leq 1000 \text{ bar}$	
G1/2" EN 837	$p > 1000 \text{ bar}$, $p \leq 1600 \text{ bar}$	

NOTE - Please refer to data sheet or contact sales department at BD|SENSORS regarding max. permitted pressure of device.

3.7 Mounting steps for NPT connections

- ✓ Suitable fluid-compatible sealing material, e.g. PTFE tape, is available.
- 1 Screw the device into the corresponding thread by hand
 - 2 Then tighten it using an open-end wrench. Permissible tightening torques for pressure transmitter:
 - 1/4" NPT: approx. 30 Nm; 1/2" NPT: approx. 70 Nm

3.8 Mounting steps for G1" cone connection

- 1 Screw the device into the mating thread by hand (seal produced metallically)
- 2 Then tighten it using an open-end wrench. Permissible tightening torques for pressure transmitter:
 - $p_N < 10 \text{ bar}$: 30 Nm
 - $p_N \geq 10 \text{ bar}$: 60 Nm

3.9 Mounting steps for internal threads M20x1.5 and 9/16" UNF (for high-pressure devices)

	DANGER - Due to wrong installation - Do not use any seal!
--	--

NOTE - The high-pressure tube will seal metal-to-metal in the chamfer of the pressure port. (sealing cone 60°)

- 1 Screw the high-pressure fitting into the internal thread of the pressure transmitter.
- 2 Then tighten it using an open-end wrench. The required tightening torque depends on the manufacturer's specifications for the high-pressure pipe you are using. (permissible tightening torque for pressure transmitter: max 120 Nm)

3.10 Mounting steps for dairy pipe connections

- ✓ The O-ring is undamaged and seated in the designated groove.
 - ✓ Chapter "3.2 and/or 3.3" have been noticed. EHEDG conformity is only ensured in combination with an approved seal for codes M73, M75, M76. This is e.g.: ASEPTO-STAR k-flex upgrade seal by Kieselmann GmbH
- 1 Centre the dairy pipe connection in the counterpart.
 - 2 Screw the cup nut onto the mounting part.
 - 3 Then tighten it using a hook wrench.

3.11 Mounting steps for Clamp and Varivent® connections

- ✓ A suitable seal for the measured fluid and the pressure to be measured is available.
 - ✓ Chapter "3.2 and/or 3.3" have been noticed. EHEDG conformity is only ensured in combination with an approved seal. This is e.g.: for Clamp connections - codes C61, C62, C63: T-ring seal from Combifit International B.V. for Varivent® connections - codes P40, P41: EPDM-O-ring which is FDA-listed
- Note, that P40 can only be used for tank flanges.
- 1 Place the seal onto the corresponding mounting part.
 - 2 Centre the clamp connection or Varivent® connection above the counterpart with seal.
 - 3 Then fit the device with a suitable fastening element (e. g. semi-ring or retractable ring clamp) according to the supplier's instructions.

3.12 Mounting steps for flange connections

- ✓ A suitable seal for the measured fluid and the pressure to be measured is available. (e.g. a fiber seal)
- 1 Put the seal between connecting flange and counter flange
 - 2 Install the device with 4 resp. 8 screws (depending on flange version) on the counter fl

NOTE - On devices with **field housing**, the terminal clamps are situated under the metal cap. To install the device electrically, the cap must be screwed off. The connection must be made such that the isolation distances according to standard are observed and that loosening of the connecting lines is impossible. Before the cap is screwed on again, the O-ring and the sealing surface on the housing have to be checked for damages and if necessary to be changed! Afterwards screw the metal cap on by hand and make sure that the field housing is firmly locked again.

NOTE - for devices with **cable outlet**

- When routing the cable, following bending radii have to be complied with:

cable without ventilation tube:

- static installation: 8-fold cable diameter
- dynamic application: 12-fold cable diameter

cable with ventilation tube:

- static installation: 10-fold cable diameter
- dynamic application: 20-fold cable diameter

- In case of devices with **cable outlet** and integrated ventilation tube, the PTFE filter located at the cable end on the air tube must neither be damaged nor removed! Route the end of the cable into an area or suitable connection box which is as dry as possible and free from aggressive gases, in order to prevent any damage.

- For a clear identification, the intrinsically safe cables are marked with light blue shrink tubing (over the cable insulation). If the cable has to be modified (e. g. shortened) and the marking at the cable end has been lost in the process, it must be restored (for example, by marking it again with light blue shrink tubing or an appropriate identification sign).

NOTE - Use a shielded and twisted multicore cable for the electrical connection.

4.2 Conditions for the IS-area

Danger generated by electrostatic charging

 DANGER	Danger of death from explosion
	<ul style="list-style-type: none"> - Explosion hazard due to spark formation from electrostatic charging of plastic components. - For devices with cable, the cable must be installed tightly. Generally, a shielded cable must be used. - Do not clean the device and, if applicable, the connection cable, in a dry state! Use a moist cloth, for example.

The following warning sign is affixed on devices with plastic components.

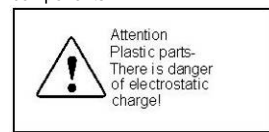

Fig. 2: Warning sign

NOTE - The warning sign must not be removed from the device!

Particularity for TRIM TRIO® connector (code 5T2)

For devices with TRIM TRIO® connector by SOURIAU, the use in explosion-hazardous areas is restricted. This design type can be identified by the code "5T2" in the "Electrical Connection" segment of the order code. The identification on the manufacturing label of the device as well as the order documents provide information on the approved areas of application.

Overvoltage protection

If the pressure transmitter is used as electrical equipment of category 1 G, then a suitable overvoltage protection device must be connected in series (attend the valid regulations for operating safety as well as EN60079-14).

Schematic circuit

The operation of an intrinsically safe transmitter in intrinsic safe areas requires special care when selecting the necessary Zener barrier or transmitter repeater devices to allow the utilization of the device's properties to the full extent. The following diagram shows a typical arrangement of power supply, Zener barrier and transmitter.

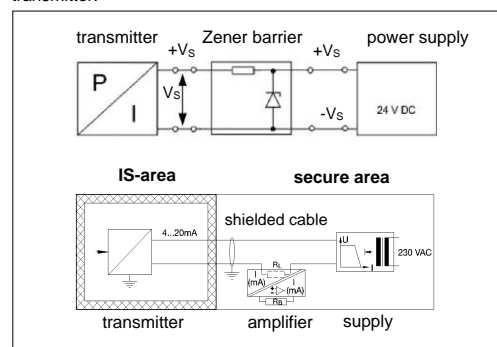



Fig. 3 circuit diagrams

NOTE - Observe item (17) of the type-examination certificate which specifies special conditions for intrinsically safe operation.

Exemplary circuit description

The supply voltage of e.g. 24 V_{DC} provided by the power supply is led across the Zener barrier. The Zener barrier contains series resistances and breakdown diodes as protective components. Subsequently, the operating voltage is applied to the transmitter and, depending on the pressure, a particular signal current flows.

 DANGER	Danger of death from explosion
	<ul style="list-style-type: none"> - Operation of intrinsically safe devices as zone-0 equipment only with ungrounded and galvanically isolated power supply.

Functional selection criteria for Zener barriers and galvanic power supply

The minimum supply voltage V_{S min} of the transmitter must not fall short since a correct function of the device can otherwise not be guaranteed. The minimum supply voltage has been defined in the respective product-specific data sheet under "Output signal / supply".

When using a galvanically insulated amplifier with linear bonding, note that the terminal voltage of the transmitter will decrease like it does with a Zener barrier. Furthermore, you have to note that the supply will additionally decrease with an optionally used signal amplifier.

Test criteria for the selection of the Zener barrier

In order not to fall below V_{S min}, it is important to verify which minimum supply voltage is available at full level control of the transmitter. The full level control, i.e. a maximum or nominal output signal (20 mA), can be reached by applying the maximum physical input signal (pressure).

The technical data of the barrier will usually provide the information needed for the selection of the Zener barrier. However, the value can also be calculated. If a maximum signal current of 0.02 A is assumed, then – according to Ohm's law – a particular voltage drop will result from the series resistance of the Zener barrier.

This voltage drop is subtracted by the voltage of the power supply and as a result, the terminal voltage is obtained which is applied on the transmitter at full level control. If this voltage is smaller than the minimum supply voltage, another barrier or a higher supply voltage should be chosen.

NOTE - When selecting the ballasts, the maximum operating conditions according to the EU-type examination certificate must be observed. When assessing these, refer to their current data sheets to ensure that the entire interconnection of intrinsically safe components remains intrinsically safe.

Calculation example for the selection of the Zener barrier

The nominal voltage of the power supply in front of the Zener barrier is 24 V_{DC} ± 5 %. This results in:

- maximum supply voltage:
 $V_{Sup\ max} = 24\ V \cdot 1.05 = 25.2\ V$
- minimum supply voltage:
 $V_{Sup\ min} = 24\ V \cdot 0.95 = 22.8\ V$

The series resistance of the Zener barrier is listed with 295 ohm. The following values must still be calculated:

- voltage drop at the barrier (with full conduction):
 $V_{ab\ barrier} = 295\ \Omega \cdot 0.02\ A = 5.9\ V$
- terminal voltage at the transmitter with Zener barrier:
 $V_{KI} = V_{Sup\ min} - V_{ab\ Barriere} = 22.8\ V - 5.9\ V = 16.9\ V$
- minimum supply voltage of the transmitter (according to data sheet):
 $V_{KI\ min} = 12\ V_{DC}$ (corresponding to V_{S min})

Condition:

$$V_{KI} \geq V_{KI\ min}$$

Result:

The terminal voltage of the transmitter with Zener barrier lies at 16.9 V and is therefore higher than the minimum supply voltage of the transmitter which lies at 12 V_{DC}. This means, the Zener barrier has been selected correctly regarding the supply voltage.

NOTE - Note that no line resistances have been listed in this calculation. However, these will lead to an additional voltage drop that must be considered.

4.3 Electrical installation

Establish the electrical connection of the device according to the technical data shown on the manufacturing label, the following table and the wiring diagram.

Pin configuration:

Electrical connections	ISO 4400	Binder 723 (5-pin)	M12x1 (4-pin)
Supply +	1	3	1
Supply -	2	4	2
Shield	ground pin	5	4

Electrical connections	Buccaneer (4-pin)	TRIM TRIO® (4-pin)
Supply +	1	1
Supply -	2	2
Shield	4	4

Electrical connections	Bayonet MIL-C-26482 (10-6)
Supply +	A
Supply -	B
Shield	pressure port

Electrical connections	Field housing	Cable colours (IEC 60757)
Supply +	IN +	WH (white)
Supply -	IN -	BN (brown)
Shield		GNYE (green-yellow)

Wiring diagram:

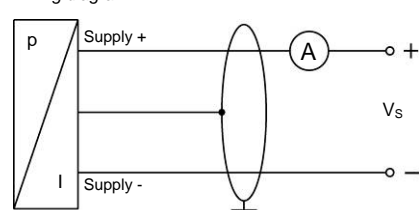

5. Commissioning



 DANGER	Danger of death from explosion, airborne parts, leaking fluid, electric shock
	<ul style="list-style-type: none"> - Explosion hazard if the operating voltage is too high (max. 28 V_{DC})! - Operate the device only within the specification! (according to data sheet and EU-type examination certificate)

- ✓ The device has been installed properly.
- ✓ The device does not have any visible defect.

In case of highly precise devices with an accuracy of 0.1 % FSO, a microcontroller-controlled electronic system is used for signal processing. This electronic system is used for signal improvement. Due to the principle, the processing of measured values requires a longer time than with purely analogue sensors, which only comprise amplification circuitry. Due to the longer processing time, the output signal follows the measured value not continuously but in jumps. In case of relatively stable and slowly changing measured values, this property plays a minor role. Compare this with the information on the adjusting time in the data sheet.

In the case of i-devices with optional communication interfaces can also be configured by these electronics. Offset, span and damping are programmable within the limits given in the data sheet. For configuring the device, the programming kit CIS 510 consisting of Adapt 1, Windows® compatible programming software P-Scale 510, power supply and connecting cable is necessary. This can be ordered additionally from BD|SENSORS.

6. Maintenance

 DANGER	Danger of death from airborne parts, leaking fluids, electric shock
	<ul style="list-style-type: none"> - Always service the device in a depressurized and de-energized condition!
 WARNING	Danger of injury from aggressive fluids or pollutants
	<ul style="list-style-type: none"> - Depending on the measured medium, this may constitute a danger to the operator. - Wear suitable protective clothing e.g. gloves, safety goggles.

If necessary, clean the housing of the device using a moist cloth and a non-aggressive cleaning solution.

During the cleaning processes, note the compatibility of the cleaning media used in combination with the media-wetted materials of the pressure measuring devices. Permissible concentrations and temperatures must be observed. Verification/validation by the user is essential.



For EHEDG certified devices in tanks, the cleaning device must be positioned in such a way that the sensor is directly assessed and wetted for cleaning. The device has been developed for Cleaning in Place (CIP) applications and must not be dismantled for cleaning.

Deposits or contamination may occur on the diaphragm/pressure port in case of certain media. Depending on kind and quality of the process, suitable cyclical maintenance intervals must be specified by the operator. As part of this, regular checks must be carried out regarding corrosion, damage of diaphragm/seal(s) and signal shift. A periodical replacement of the seal(s) may be necessary.

If the diaphragm is calcified, it is recommended to send the device to BD|SENSORS for decalcification. Please note the chapter "Service / repair" below.

NOTE - Wrong cleaning or improper touch may cause an irreparable damage on the diaphragm. Therefore, never use pointed objects or pressured air for cleaning the diaphragm.

7. Troubleshooting

 DANGER	Danger of death from airborne parts, leaking fluids, electric shock
	<ul style="list-style-type: none"> - If malfunctions cannot be resolved, put the device out of service (proceed according to chapter 8 up to 10)
 DANGER	Danger of death from explosion
	<ul style="list-style-type: none"> - As a matter of principle, work on energized parts, except for intrinsically safe circuits, is prohibited while there is an explosion hazard.

In case of malfunction, it must be checked whether the device has been correctly installed mechanically and electrically. Use the following table to analyse the cause and resolve the malfunction, if possible.

Fault: no output signal	Possible cause	Fault detection / remedy
Connected incorrectly	Checking of connections	
Conductor/wire breakage	Checking of all line connections.	
Defective measuring device (signal input)	Checking of ammeter (miniature fuse) or of analogue input of your signal processing unit	



Fault: analogue output signal too low	Possible cause	Fault detection / remedy
Load resistance too high	Checking of load resistance (value)	
Supply voltage too low	Checking of power supply output voltage	
Defective energy supply	Checking of the power supply and the supply voltage being applied to the device	

Fault: slight shift of the output signal	Possible cause	Fault detection / remedy
Diaphragm of sensor is severely contaminated, calcified or crusted	Checking of diaphragm; if necessary, contact BD SENSORS	

Fault: large shift of the output signal	Possible cause	Fault detection / remedy
Diaphragm of sensor is damaged (caused by overpressure or mechanically)	Checking of diaphragm; when damaged, contact BD SENSORS	

Fault: wrong or no output signal	Possible cause	Fault detection / remedy
Cable damaged mechanically, thermally or chemically	Checking of cable; pitting corrosion on the stainless-steel housing as a result of damage on cable; when damaged, contact BD SENSORS	

8. Removal from service

 DANGER	Danger of death from airborne parts, leaking fluids, electric shock
	<ul style="list-style-type: none"> - Disassemble the device in a depressurized and de-energized condition!
 WARNING	Danger of injury from aggressive media or pollutants
	<ul style="list-style-type: none"> - Depending on the measured medium, this may constitute a danger to the operator. - Wear suitable protective clothing e.g. gloves, goggles.

NOTE - After dismantling, mechanical connections must be fitted with protective caps.

9. Service / repair

Information on service / repair:

- www.bdsensors.de
- info@bdsensors.de
- Service phone: +49 (0) 92 35 98 11 0

9.1 Recalibration

During the life-time of a transmitter, the value of offset and span may shift. As a consequence, a deviating signal value in reference to the nominal pressure range starting point or end point may be transmitted. If one of these two phenomena occurs after prolonged use, a recalibration is recommended to ensure furthermore high accuracy.

9.2 Return

 WARNING	Danger of injury from aggressive media or pollutants
	<ul style="list-style-type: none"> - Depending on the measured medium, this may constitute a danger to the operator. - Wear suitable protective clothing e.g. gloves, goggles.

Before every return of your device, whether for recalibration, decalcification, modifications or repair, it has to be cleaned carefully and packed shatter-proofed. You have to enclose a notice of return with detailed defect description when sending the device. If your device came in contact with harmful substances, a declaration of decontamination is additionally required. Appropriate forms can be downloaded from our homepage. Download these by accessing www.bdsensors.de or request them:

info@bdsensors.de | phone: +49 (0) 92 35 / 98 11 0

In case of doubt regarding the fluid used, devices without a declaration of decontamination will only be examined after receipt of an appropriate declaration!

10. Disposal

 WARNING	Danger of injury from aggressive media or pollutants
	<ul style="list-style-type: none"> - Depending on the measured medium, this may constitute a danger to the operator. - Wear suitable protective clothing e.g. gloves, goggles.

The device must be disposed of according to the European Directive 2012/19/EU (waste electrical and electronic equipment). Waste equipment must not be disposed of in household waste!

NOTE - Dispose of the device properly!

11. Warranty terms

The warranty terms are subject to the legal warranty period of 24 months, valid from the date of delivery. If the device is used improperly, modified or damaged, we will rule out any warranty claim. A damaged diaphragm will not be accepted as a warranty case. Likewise, there shall be no entitlement to services or parts provided under warranty if the defects have arisen due to normal wear and tear.

12. EU declaration of conformity / CE

The delivered device fulfils all legal requirements. The applied directives, harmonised standards and documents are listed in

the EC declaration of conformity, which is available online at: <http://www.bdsensors.de>. Additionally, the operational safety is confirmed by the CE sign on the manufacturing label.

DX14-...



DX14B-...



DX19-...

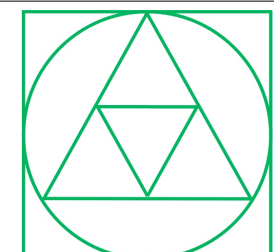
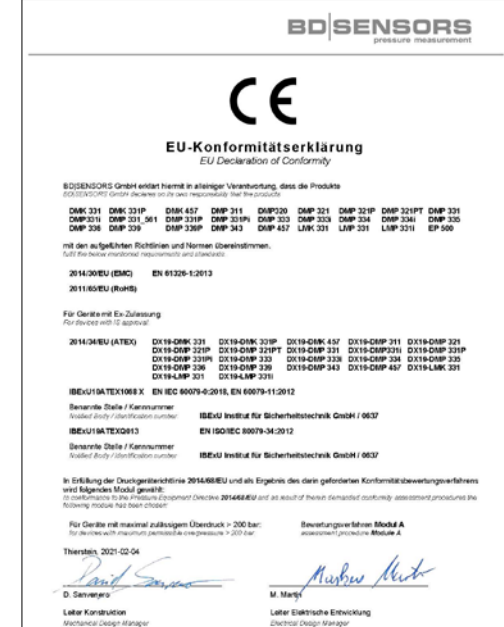

APPLIED MEASUREMENTS LIMITED