

NOTE - On devices with **field housing**, the terminal clamps are situated under the metal cap. To install the device electrically, the cap must be screwed off. The connection must be made such that the isolation distances according to standard are observed and that loosening of the connecting lines is impossible. Before the cap is screwed on again, the O-ring and the sealing surface on the housing have to be checked for damages and if necessary to be changed! Afterwards screw the metal cap on by hand and make sure that the field housing is firmly locked again.

NOTE - for devices with **cable outlet**

- When routing the cable, following bending radii have to be complied with:

cable without ventilation tube:

- static installation: 8-fold cable diameter
- dynamic application: 12-fold cable diameter

cable with ventilation tube:

- static installation: 10-fold cable diameter
- dynamic application: 20-fold cable diameter

- In case of devices with **cable outlet** and integrated ventilation tube, the PTFE filter located at the cable end on the air tube must neither be damaged nor removed! Route the end of the cable into an area or suitable connection box which is as dry as possible and free from aggressive gases, in order to prevent any damage.

- For a clear identification, the intrinsically safe cables are marked with light blue shrink tubing (over the cable insulation). If the cable has to be modified (e. g. shortened) and the marking at the cable end has been lost in the process, it must be restored (for example, by marking it again with light blue shrink tubing or an appropriate identification sign).

NOTE - Use a shielded and twisted multicore cable for the electrical connection.

4.2 Conditions for the IS-area

Danger generated by electrostatic charging

 DANGER	Danger of death from explosion
	<ul style="list-style-type: none"> - Explosion hazard due to spark formation from electrostatic charging of plastic components. - For devices with cable, the cable must be installed tightly. Generally, a shielded cable must be used. - Do not clean the device and, if applicable, the connection cable, in a dry state! Use a moist cloth, for example.

The following warning sign is affixed on devices with plastic components.

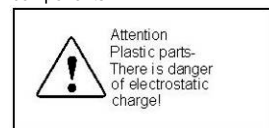

Fig. 2: Warning sign

NOTE - The warning sign must not be removed from the device!

Particularity for TRIM TRIO® connector (code 5T2)

For devices with TRIM TRIO® connector by SOURIAU, the use in explosion-hazardous areas is restricted. This design type can be identified by the code "5T2" in the "Electrical Connection" segment of the order code. The identification on the manufacturing label of the device as well as the order documents provide information on the approved areas of application.

Overvoltage protection

If the pressure transmitter is used as electrical equipment of category 1 G, then a suitable overvoltage protection device must be connected in series (attend the valid regulations for operating safety as well as EN60079-14).

Schematic circuit

The operation of an intrinsically safe transmitter in intrinsic safe areas requires special care when selecting the necessary Zener barrier or transmitter repeater devices to allow the utilization of the device's properties to the full extent. The following diagram shows a typical arrangement of power supply, Zener barrier and transmitter.

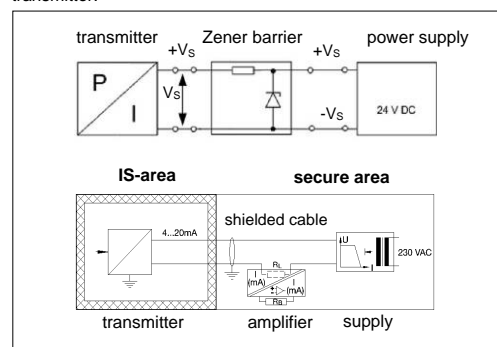



Fig. 3 circuit diagrams

NOTE - Observe item (17) of the type-examination certificate which specifies special conditions for intrinsically safe operation.

Exemplary circuit description

The supply voltage of e.g. 24 V_{DC} provided by the power supply is led across the Zener barrier. The Zener barrier contains series resistances and breakdown diodes as protective components. Subsequently, the operating voltage is applied to the transmitter and, depending on the pressure, a particular signal current flows.

 DANGER	Danger of death from explosion
	- Operation of intrinsically safe devices as zone-0 equipment only with ungrounded and galvanically isolated power supply.

Functional selection criteria for Zener barriers and galvanic power supply

The minimum supply voltage V_{S min} of the transmitter must not fall short since a correct function of the device can otherwise not be guaranteed. The minimum supply voltage has been defined in the respective product-specific data sheet under "Output signal / supply".

When using a galvanically insulated amplifier with linear bonding, note that the terminal voltage of the transmitter will decrease like it does with a Zener barrier. Furthermore, you have to note that the supply will additionally decrease with an optionally used signal amplifier.

Test criteria for the selection of the Zener barrier

In order not to fall below V_{S min}, it is important to verify which minimum supply voltage is available at full level control of the transmitter. The full level control, i.e. a maximum or nominal output signal (20 mA), can be reached by applying the maximum physical input signal (pressure).

The technical data of the barrier will usually provide the information needed for the selection of the Zener barrier. However, the value can also be calculated. If a maximum signal current of 0.02 A is assumed, then – according to Ohm's law – a particular voltage drop will result from the series resistance of the Zener barrier.

This voltage drop is subtracted by the voltage of the power supply and as a result, the terminal voltage is obtained which is applied on the transmitter at full level control. If this voltage is smaller than the minimum supply voltage, another barrier or a higher supply voltage should be chosen.

NOTE - When selecting the ballasts, the maximum operating conditions according to the EU-type examination certificate must be observed. When assessing these, refer to their current data sheets to ensure that the entire interconnection of intrinsically safe components remains intrinsically safe.

Calculation example for the selection of the Zener barrier

The nominal voltage of the power supply in front of the Zener barrier is 24 V_{DC} ± 5 %. This results in:

- maximum supply voltage:
 $V_{Sup\ max} = 24\ V \cdot 1.05 = 25.2\ V$
- minimum supply voltage:
 $V_{Sup\ min} = 24\ V \cdot 0.95 = 22.8\ V$

The series resistance of the Zener barrier is listed with 295 ohm. The following values must still be calculated:

- voltage drop at the barrier (with full conduction):
 $V_{ab\ barrier} = 295\ \Omega \cdot 0.02\ A = 5.9\ V$
- terminal voltage at the transmitter with Zener barrier:
 $V_{KI} = V_{Sup\ min} - V_{ab\ Barriere} = 22.8\ V - 5.9\ V = 16.9\ V$
- minimum supply voltage of the transmitter (according to data sheet):
 $V_{KI\ min} = 12\ V_{DC}$ (corresponding to V_{S min})

Condition:

$$V_{KI} \geq V_{KI\ min}$$

Result:

The terminal voltage of the transmitter with Zener barrier lies at 16.9 V and is therefore higher than the minimum supply voltage of the transmitter which lies at 12 V_{DC}. This means, the Zener barrier has been selected correctly regarding the supply voltage.

NOTE - Note that no line resistances have been listed in this calculation. However, these will lead to an additional voltage drop that must be considered.

4.3 Electrical installation

Establish the electrical connection of the device according to the technical data shown on the manufacturing label, the following table and the wiring diagram.

Pin configuration:

Electrical connections	ISO 4400	Binder 723 (5-pin)	M12x1 (4-pin)
Supply +	1	3	1
Supply -	2	4	2
Shield	ground pin	5	4

Electrical connections	Buccaneer (4-pin)	TRIM TRIO® (4-pin)
Supply +	1	1
Supply -	2	2
Shield	4	4

Electrical connections	Bayonet MIL-C-26482 (10-6)
Supply +	A
Supply -	B
Shield	pressure port

Electrical connections	Field housing	Cable colours (IEC 60757)
Supply +	IN +	WH (white)
Supply -	IN -	BN (brown)
Shield		GNYE (green-yellow)

Wiring diagram:

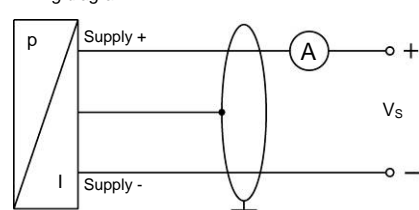

5. Commissioning



 DANGER	Danger of death from explosion, airborne parts, leaking fluid, electric shock
	<ul style="list-style-type: none"> - Explosion hazard if the operating voltage is too high (max. 28 V_{DC})! - Operate the device only within the specification! (according to data sheet and EU-type examination certificate)

- ✓ The device has been installed properly.
- ✓ The device does not have any visible defect.

In case of highly precise devices with an accuracy of 0.1 % FSO, a microcontroller-controlled electronic system is used for signal processing. This electronic system is used for signal improvement. Due to the principle, the processing of measured values requires a longer time than with purely analogue sensors, which only comprise amplification circuitry. Due to the longer processing time, the output signal follows the measured value not continuously but in jumps. In case of relatively stable and slowly changing measured values, this property plays a minor role. Compare this with the information on the adjusting time in the data sheet.

In the case of i-devices with optional communication interfaces can also be configured by these electronics. Offset, span and damping are programmable within the limits given in the data sheet. For configuring the device, the programming kit CIS 510 consisting of Adapt 1, Windows® compatible programming software P-Scale 510, power supply and connecting cable is necessary. This can be ordered additionally from BD|SENSORS.

6. Maintenance

 DANGER	Danger of death from airborne parts, leaking fluids, electric shock
	- Always service the device in a depressurized and de-energized condition!
 WARNING	Danger of injury from aggressive fluids or pollutants
	<ul style="list-style-type: none"> - Depending on the measured medium, this may constitute a danger to the operator. - Wear suitable protective clothing e.g. gloves, safety goggles.

If necessary, clean the housing of the device using a moist cloth and a non-aggressive cleaning solution.

During the cleaning processes, note the compatibility of the cleaning media used in combination with the media-wetted materials of the pressure measuring devices. Permissible concentrations and temperatures must be observed. Verification/validation by the user is essential.



For EHEDG certified devices in tanks, the cleaning device must be positioned in such a way that the sensor is directly assessed and wetted for cleaning. The device has been developed for Cleaning in Place (CIP) applications and must not be dismantled for cleaning.

Deposits or contamination may occur on the diaphragm/pressure port in case of certain media. Depending on kind and quality of the process, suitable cyclical maintenance intervals must be specified by the operator. As part of this, regular checks must be carried out regarding corrosion, damage of diaphragm/seal(s) and signal shift. A periodical replacement of the seal(s) may be necessary.

If the diaphragm is calcified, it is recommended to send the device to BD|SENSORS for decalcification. Please note the chapter "Service / repair" below.

NOTE - Wrong cleaning or improper touch may cause an irreparable damage on the diaphragm. Therefore, never use pointed objects or pressured air for cleaning the diaphragm.

7. Troubleshooting

 DANGER	Danger of death from airborne parts, leaking fluids, electric shock
	- If malfunctions cannot be resolved, put the device out of service (proceed according to chapter 8 up to 10)
 DANGER	Danger of death from explosion
	- As a matter of principle, work on energized parts, except for intrinsically safe circuits, is prohibited while there is an explosion hazard.

In case of malfunction, it must be checked whether the device has been correctly installed mechanically and electrically. Use the following table to analyse the cause and resolve the malfunction, if possible.

Fault: no output signal	Possible cause	Fault detection / remedy
Connected incorrectly	Checking of connections	
Conductor/wire breakage	Checking of all line connections.	
Defective measuring device (signal input)	Checking of ammeter (miniature fuse) or of analogue input of your signal processing unit	



Fault: analogue output signal too low	Possible cause	Fault detection / remedy
Load resistance too high	Checking of load resistance (value)	
Supply voltage too low	Checking of power supply output voltage	
Defective energy supply	Checking of the power supply and the supply voltage being applied to the device	

Fault: slight shift of the output signal	Possible cause	Fault detection / remedy
Diaphragm of sensor is severely contaminated, calcified or crusted	Checking of diaphragm; if necessary, contact BD SENSORS	

Fault: large shift of the output signal	Possible cause	Fault detection / remedy
Diaphragm of sensor is damaged (caused by overpressure or mechanically)	Checking of diaphragm; when damaged, contact BD SENSORS	

Fault: wrong or no output signal	Possible cause	Fault detection / remedy
Cable damaged mechanically, thermally or chemically	Checking of cable; pitting corrosion on the stainless-steel housing as a result of damage on cable; when damaged, contact BD SENSORS	

8. Removal from service

 DANGER	Danger of death from airborne parts, leaking fluids, electric shock
	- Disassemble the device in a depressurized and de-energized condition!
 WARNING	Danger of injury from aggressive media or pollutants
	<ul style="list-style-type: none"> - Depending on the measured medium, this may constitute a danger to the operator. - Wear suitable protective clothing e.g. gloves, goggles.

NOTE - After dismantling, mechanical connections must be fitted with protective caps.

9. Service / repair

Information on service / repair:

- www.bdsensors.de
- info@bdsensors.de
- Service phone: +49 (0) 92 35 98 11 0

9.1 Recalibration

During the life-time of a transmitter, the value of offset and span may shift. As a consequence, a deviating signal value in reference to the nominal pressure range starting point or end point may be transmitted. If one of these two phenomena occurs after prolonged use, a recalibration is recommended to ensure furthermore high accuracy.

9.2 Return

 WARNING	Danger of injury from aggressive media or pollutants
	<ul style="list-style-type: none"> - Depending on the measured medium, this may constitute a danger to the operator. - Wear suitable protective clothing e.g. gloves, goggles.

Before every return of your device, whether for recalibration, decalcification, modifications or repair, it has to be cleaned carefully and packed shatter-proofed. You have to enclose a notice of return with detailed defect description when sending the device. If your device came in contact with harmful substances, a declaration of decontamination is additionally required. Appropriate forms can be downloaded from our homepage. Download these by accessing www.bdsensors.de or request them:

info@bdsensors.de | phone: +49 (0) 92 35 / 98 11 0

In case of doubt regarding the fluid used, devices without a declaration of decontamination will only be examined after receipt of an appropriate declaration!

10. Disposal

 WARNING	Danger of injury from aggressive media or pollutants
	<ul style="list-style-type: none"> - Depending on the measured medium, this may constitute a danger to the operator. - Wear suitable protective clothing e.g. gloves, goggles.

The device must be disposed of according to the European Directive 2012/19/EU (waste electrical and electronic equipment). Waste equipment must not be disposed of in household waste!

NOTE - Dispose of the device properly!

11. Warranty terms

The warranty terms are subject to the legal warranty period of 24 months, valid from the date of delivery. If the device is used improperly, modified or damaged, we will rule out any warranty claim. A damaged diaphragm will not be accepted as a warranty case. Likewise, there shall be no entitlement to services or parts provided under warranty if the defects have arisen due to normal wear and tear.

12. EU declaration of conformity / CE

The delivered device fulfils all legal requirements. The applied directives, harmonised standards and documents are listed in

the EC declaration of conformity, which is available online at: <http://www.bdsensors.de>. Additionally, the operational safety is confirmed by the CE sign on the manufacturing label.

DX14-...



DX14B-...



DX19-...

